

N-Ch 40V Fast Switching MOSFETs



- ★ Green Device Available
- ★ Super Low Gate Charge
- ★ Excellent CdV/dt effect decline
- ★ Advanced high cell density Trench technology

Product Summary

BVDSS	RDSON	ID
40V	3.8 mΩ	100A

Description

The XXW100N04F is the high cell density trenched N-ch MOSFETs, which provide excellent RDSON and gate charge for most of the synchronous buck converter applications. The XXW100N04F meet the RoHS and Green Product requirement, 100% EAS guaranteed with full function reliability approved.

PDFN5060-8L Pin Configuration

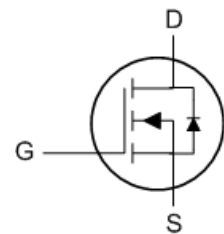
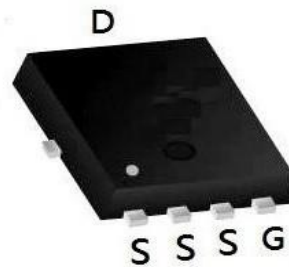

Absolute Maximum Ratings (@ $T_c = 25^\circ\text{C}$ unless otherwise specified)

Symbol	Parameter	Value	Units
V_{DS}	Drain-to-Source Voltage	40	V
V_{GS}	Gate-to-Source Voltage	± 20	V
I_D	Continuous Drain Current	$T_c = 25^\circ\text{C}$	100
		$T_c = 100^\circ\text{C}$	50
I_{DM}	Pulsed Drain Current ⁽¹⁾	320	A
E_{AS}	Single Pulsed Avalanche Energy ⁽²⁾	156	mJ
P_D	Power Dissipation	$T_c = 25^\circ\text{C}$	142
$R_{\theta JA}$	Thermal Resistance, Junction to Ambient ⁽³⁾	31	$^\circ\text{C/W}$
$R_{\theta JC}$	Thermal Resistance, Junction to Case	0.88	
T_J, T_{STG}	Junction & Storage Temperature Range	-55 to 150	$^\circ\text{C}$

N-Ch 40V Fast Switching MOSFETs
Electrical Characteristics ($T_J = 25^\circ\text{C}$ unless otherwise specified)

Symbol	Parameter	Conditions	Min.	Typ.	Max.	Unit
Off Characteristics						
$V_{(BR)DS}$	Drain-Source Breakdown Voltage	$I_D = 250\mu\text{A}, V_{GS} = 0\text{V}$	40	-	-	V
I_{DS}	Zero Gate Voltage Drain Current	$V_{DS} = 40\text{V}, V_{GS} = 0\text{V}$	-	-	1.0	μA
I_{GS}	Gate-Body Leakage Current	$V_{DS} = 0\text{V}, V_{GS} = \pm 20\text{V}$	-	-	± 100	nA
On Characteristics						
$V_{GS(t)}$	Gate Threshold Voltage	$V_{DS} = V_{GS}, I_D = 250\mu\text{A}$	1.3	1.9	2.5	V
$R_{DS(ON)}$	Static Drain-Source ON-Resistance ⁽⁴⁾	$V_{GS} = 10\text{V}, I_D = 30\text{A}$	-	3.8	4.9	$\text{m}\Omega$
		$V_{GS} = 4.5\text{V}, I_D = 20\text{A}$	-	5.7	7.4	$\text{m}\Omega$
Dynamic Characteristics						
C_{is}	Input Capacitance	$V_{GS} = 0\text{V}, V_{DS} = 20\text{V}, f = 1\text{MHz}$	-	3778	-	pF
C_{os}	Output Capacitance		-	267	-	pF
C_{rs}	Reverse Transfer Capacitance		-	224	-	pF
Q_g	Total Gate Charge	$V_{GS} = 0 \text{ to } 10\text{V}, V_{DS} = 20\text{V}, I_D = 30\text{A}$	-	73	-	nC
Q_{gs}	Gate Source Charge		-	15	-	nC
Q_{gd}	Gate Drain ("Miller") Charge		-	16	-	nC
Switching Characteristics						
$t_{d(on)}$	Turn-On Delay Time	$V_{GS} = 10\text{V}, V_{DD} = 20\text{V}, I_D = 30\text{A}, R_{GEN} = 3\Omega$	-	12	-	ns
t_r	Turn-On Rise Time		-	29	-	ns
$t_{d(off)}$	Turn-Off Delay Time		-	60	-	ns
t_f	Turn-Off Fall Time		-	16	-	ns
Drain-Source Diode Characteristics and Max Ratings						
I	Maximum Continuous Drain to Source Diode Forward Current		-	-	100	A
I_S	Maximum Pulsed Drain to Source Diode Forward Current		-	-	320	A
V_S	Drain to Source Diode Forward Voltage	$V_{GS} = 0\text{V}, I_S = 30\text{A}$	-	-	1.2	V
t_{rr}	Body Diode Reverse Recovery Time	$I_F = 20\text{A}, di/dt = 100\text{A}/\mu\text{s}$	-	16	-	ns
Q_{rr}	Body Diode Reverse Recovery Charge		-	10	-	nC

- Note:
1. Repetitive Rating: Pulse Width Limited by Maximum Junction Temperature.
 2. EAS condition: Starting $T_J=25^\circ\text{C}$, $V_{DD}=20\text{V}$, $V_G=10\text{V}$, $R_G=25\text{ohm}$, $L=0.5\text{mH}$, $I_{AS}=25\text{A}$
 3. $R_{\theta JA}$ is measured with the device mounted on a 1inch^2 pad of 2oz copper FR4 PCB
 4. Pulse Test: Pulse Width $\leq 300\mu\text{s}$, Duty Cycle $\leq 0.5\%$.

Typical Performance

Figure 1: Output Characteristics

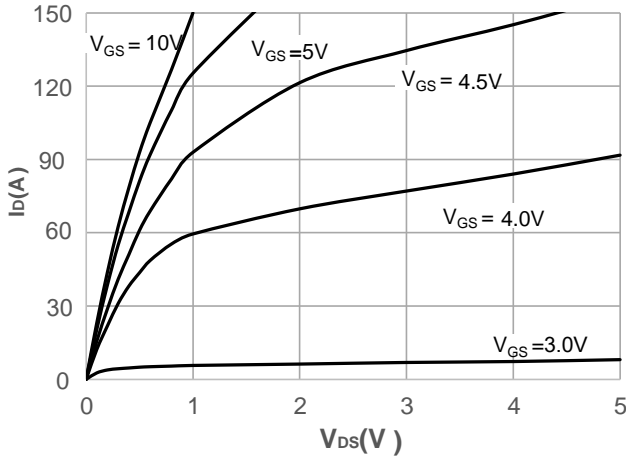

Figure 2: Typical Transfer Characteristics

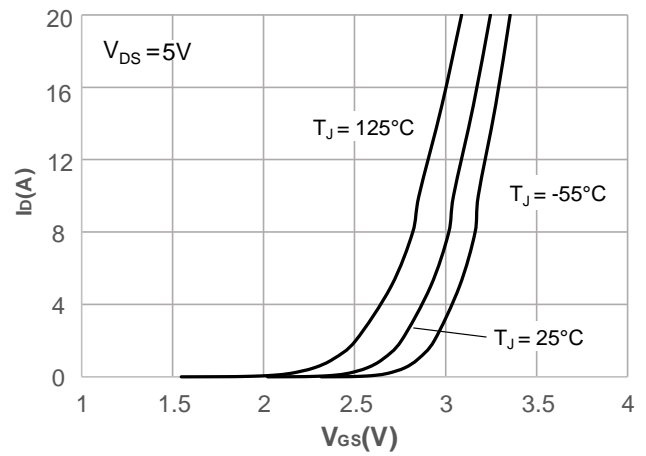

Figure 3: On-resistance vs. Drain Current

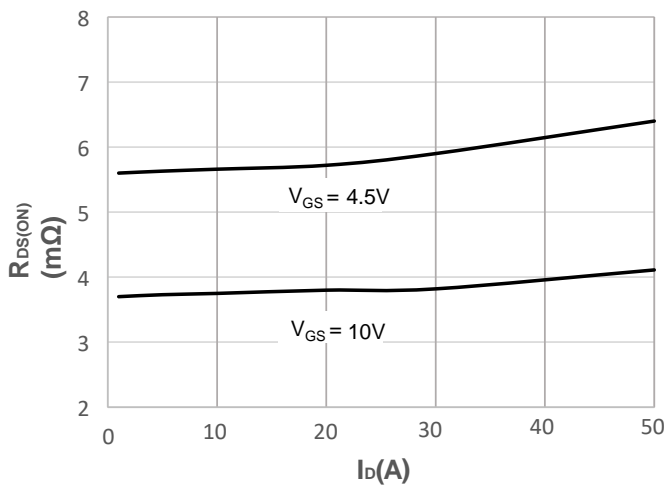

Figure 4: Body Diode Characteristics

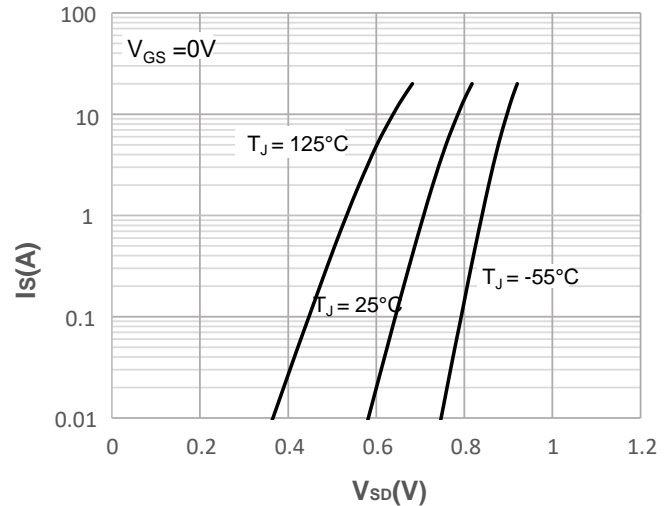

Figure 5: Gate Charge Characteristics

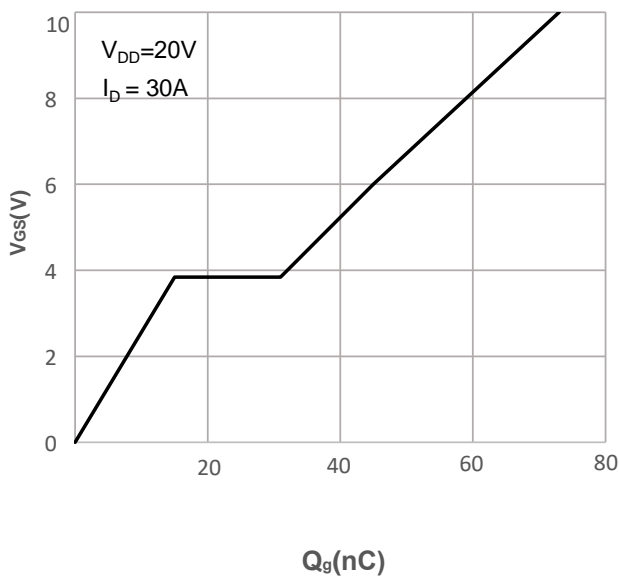
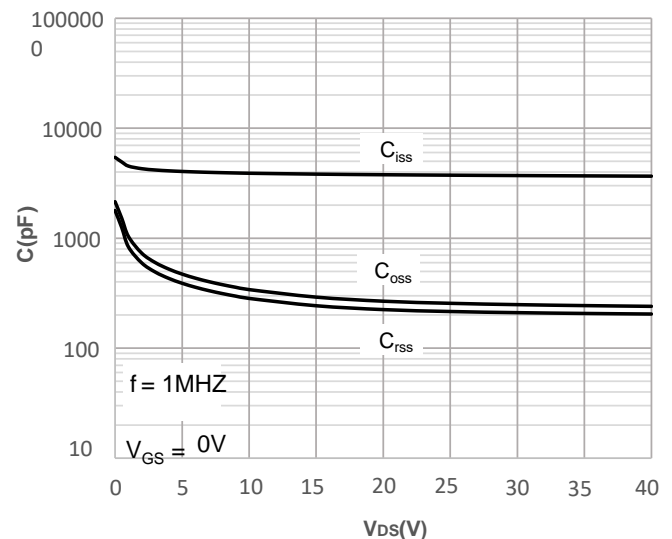

Figure 6: Capacitance Characteristics



Typical Performance

Figure 7: Normalized Breakdown voltage vs. Junction Temperature

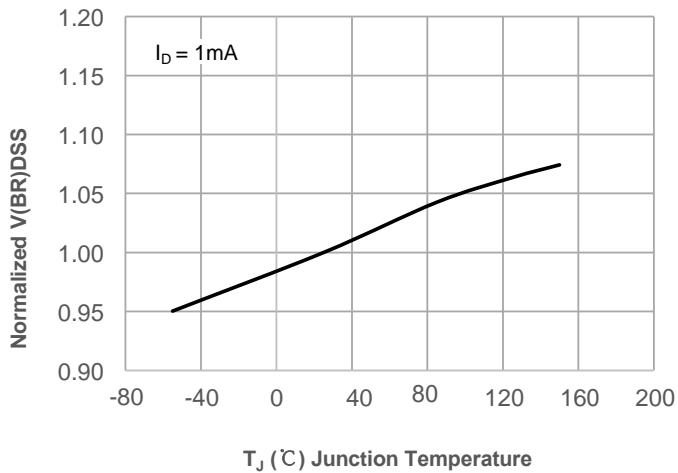

Figure 8: Normalized on Resistance vs. Junction Temperature

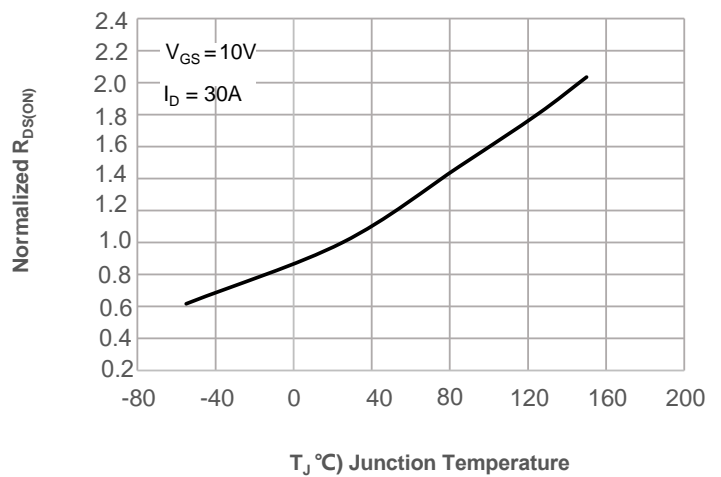

Figure 9: Maximum Safe Operating Area

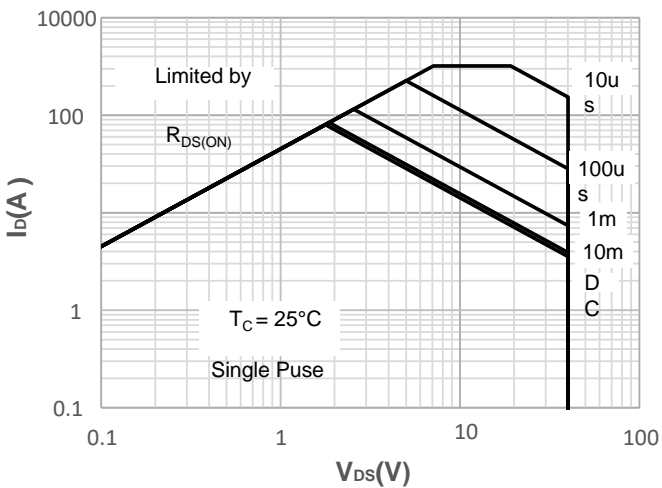

Figure 10: Maximum Continuous Drianc Current vs. Case Temperature

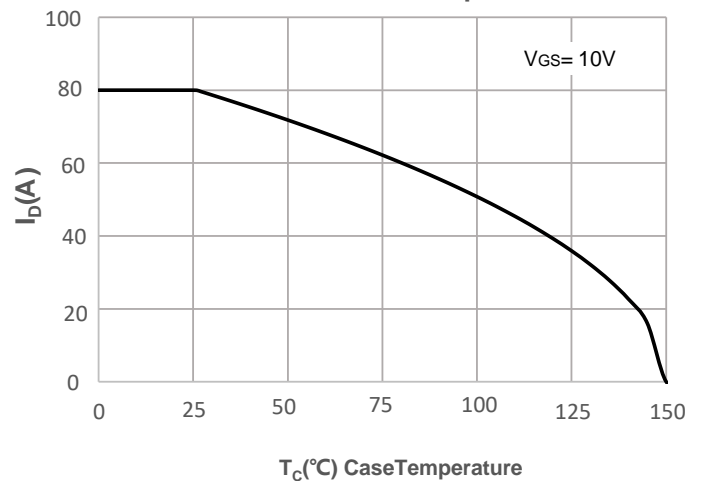

Figure 11: Normalized Maximum Transient Thermal Impedance

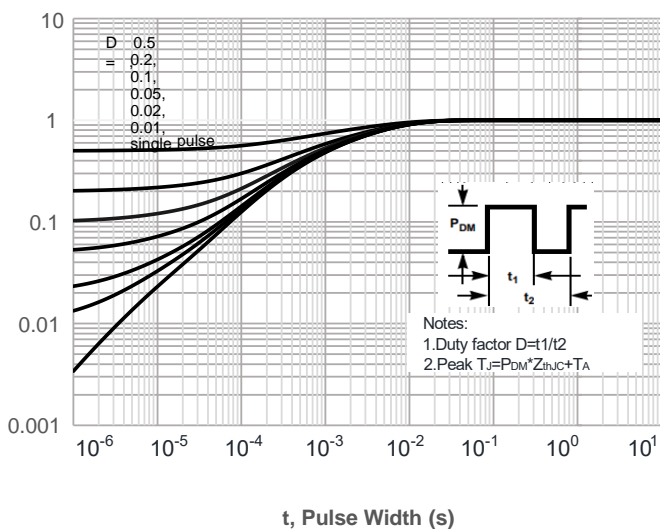
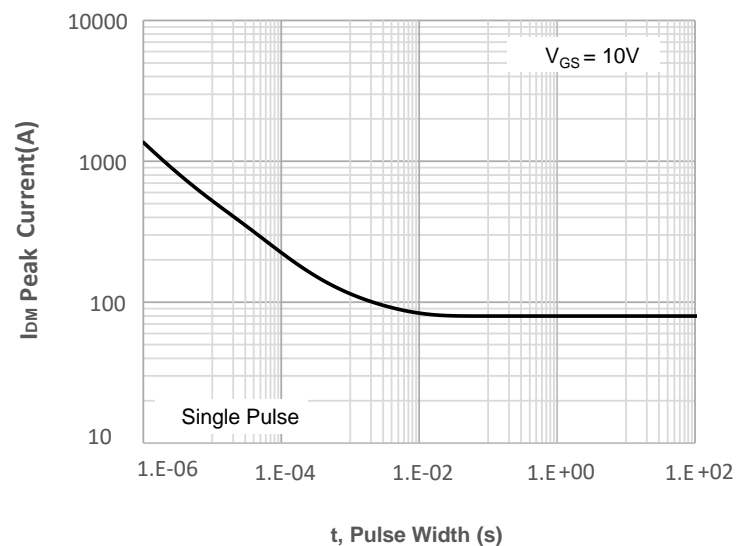

Figure 12: Peak Current Capacity



Test Circuit

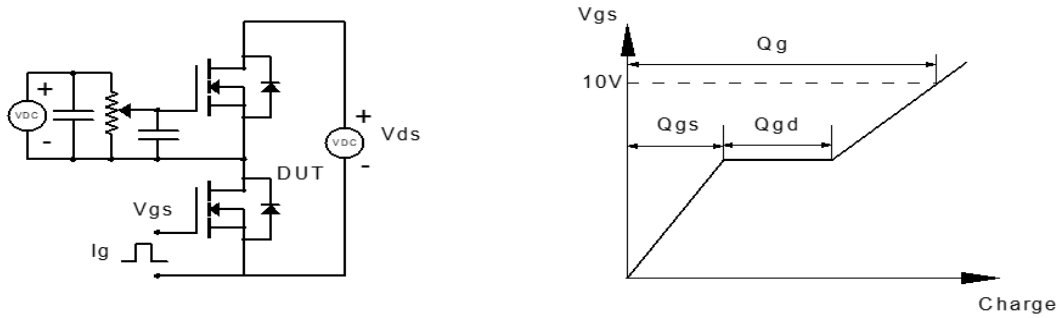

Figure 1: Gate Charge Test Circuit & Waveform

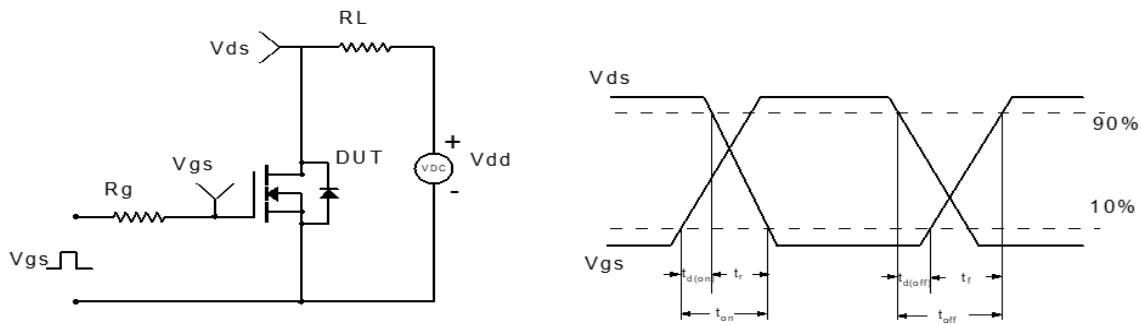

Figure 2: Resistive Switching Test Circuit & Waveform

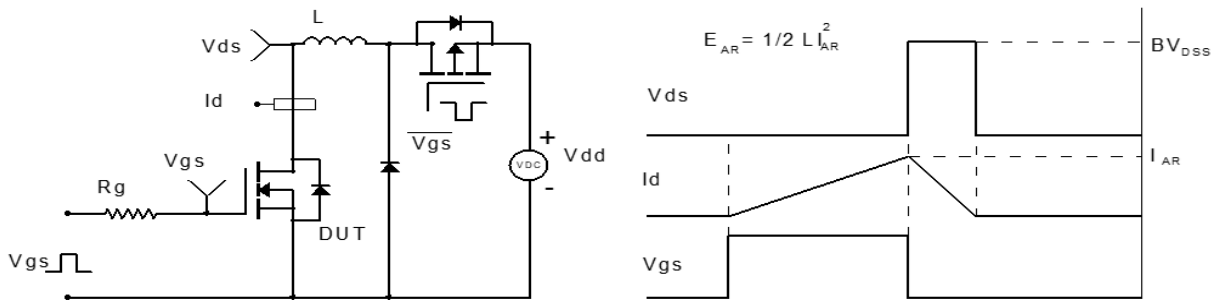

Figure 3: Unclamped Inductive Switching Test Circuit & Waveform

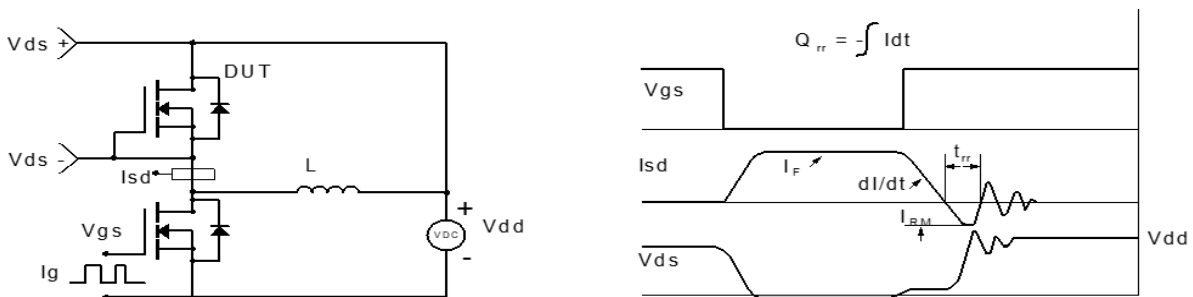
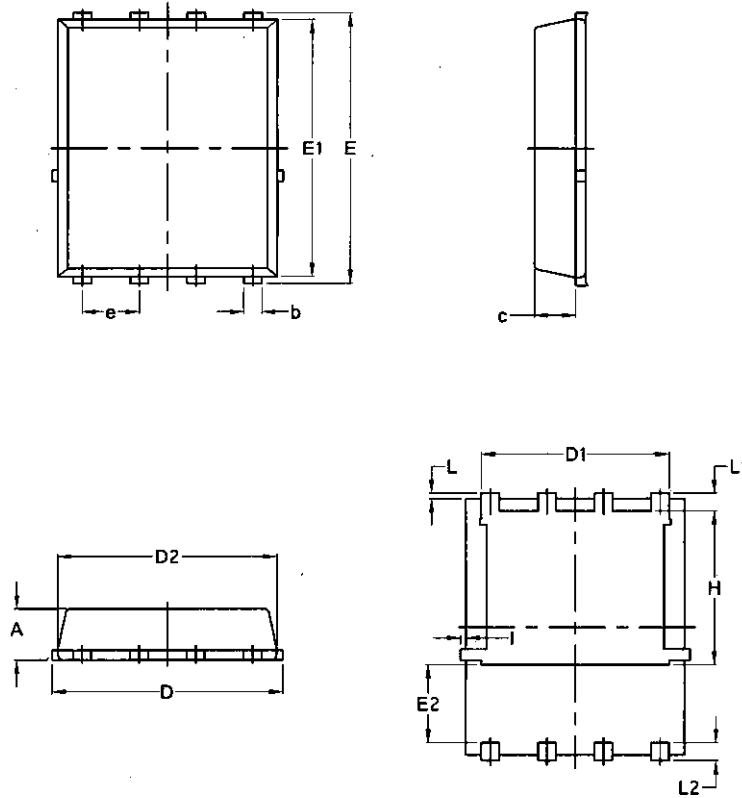

Figure 4: Diode Recovery Test Circuit & Waveform

Package Mechanical Data-PDFN5060-8L-Single

Symbol	Common			
	mm		Inch	
	Min	Max	Min	Max
A	1.03	1.17	0.0406	0.0461
b	0.34	0.48	0.0134	0.0189
c	0.824	0.0970	0.0324	0.082
D	4.80	5.40	0.1890	0.2126
D1	4.11	4.31	0.1618	0.1697
D2	4.80	5.00	0.1890	0.1969
E	5.95	6.15	0.2343	0.2421
E1	5.65	5.85	0.2224	0.2303
E2	1.60	/	0.0630	/
e	1.27 BSC		0.05 BSC	
L	0.05	0.25	0.0020	0.0098
L1	0.38	0.50	0.0150	0.0197
L2	0.38	0.50	0.0150	0.0197
H	3.30	3.50	0.1299	0.1378
I	/	0.18	/	0.0070