

Surface Mount Schottky Barrier Rectifier
 Reverse Voltage - 20 to 200V
 Forward Current - 8.0A

FEATURES

- Metal silicon junction, majority carrier conduction
- For surface mounted applications
- Low power loss, high efficiency
- High forward surge current capability
- For use in low voltage, high frequency inverters, free wheeling, and polarity protection applications

MECHANICAL DATA

- Case: SMC
- Terminals: Solderable per MIL-STD-750, Method 2026
- Approx. Weight: 0.22g / 0.0077oz

PINNING

PIN	DESCRIPTION
1	Cathode
2	Anode

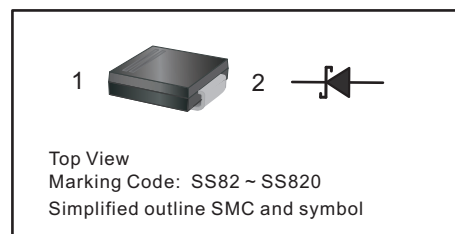

Absolute Maximum Ratings and Electrical characteristics

Ratings at 25 °C ambient temperature unless otherwise specified. Single phase, half wave, 60Hz resistive or inductive load, for capacitive load, derate by 20 %

Parameter	Symbols	SS82C	SS84C	SS86C	SS88C	SS810C	SS812C	SS815C	SS820C	Units
Maximum Repetitive Peak Reverse Voltage	V_{RRM}	20	40	60	80	100	120	150	200	V
Maximum RMS voltage	V_{RMS}	14	28	42	56	70	84	105	140	V
Maximum DC Blocking Voltage	V_{DC}	20	40	60	80	100	120	150	200	V
Maximum Average Forward Rectified Current	$I_{F(AV)}$	8.0								A
Peak Forward Surge Current, 8.3ms Single Half Sine-wave Superimposed on Rated Load (JEDEC method)	I_{FSM}	150								A
Max Instantaneous Forward Voltage at 8 A	V_F	0.45	0.55	0.70		0.85			V	
Maximum DC Reverse Current $T_a = 25^\circ\text{C}$ at Rated DC Reverse Voltage $T_a = 100^\circ\text{C}$	I_R	1.0 50								mA
Typical Junction Capacitance ⁽¹⁾	C_j	600		400					pF	
Typical Thermal Resistance ⁽²⁾	$R_{\theta JA}$	35								°C/W
Operating Junction Temperature Range	T_j	-55 ~ +150								°C
Storage Temperature Range	T_{stg}	-55 ~ +150								°C

(1) Measured at 1 MHz and applied reverse voltage of 4 V D.C

(2) P.C.B. mounted with 2.0" X 2.0" (5 X 5 cm) copper pad areas.

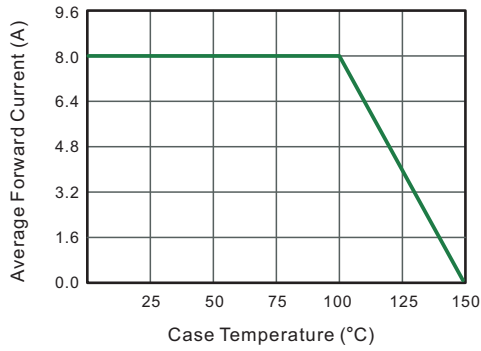
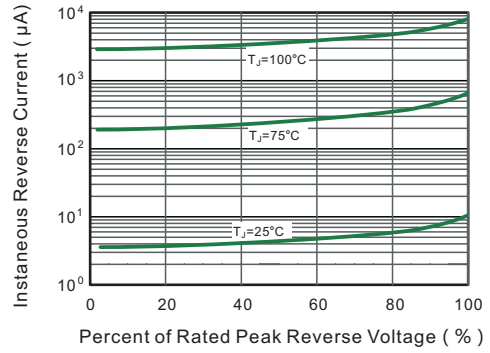
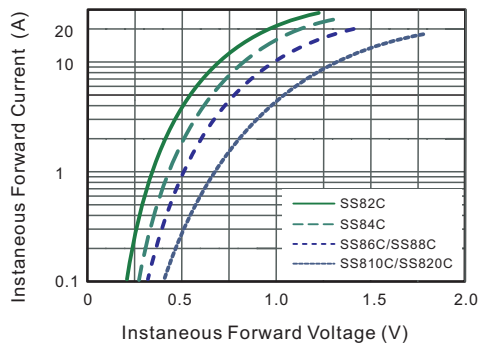
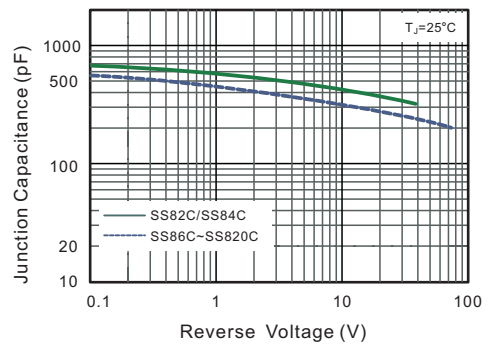
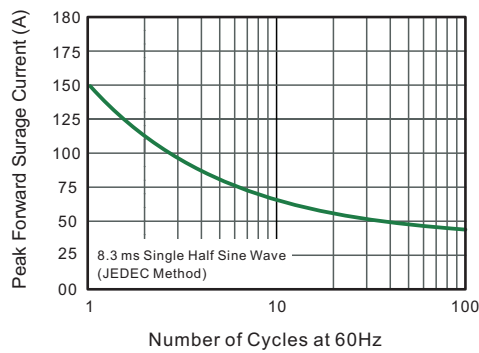
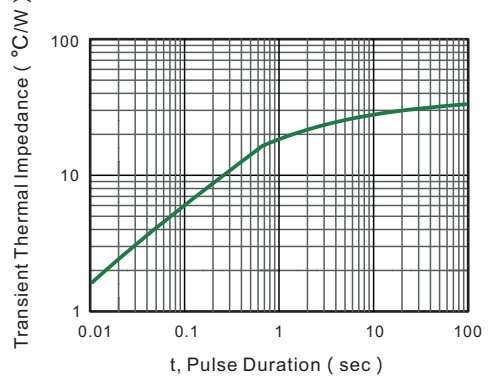
Fig.1 Forward Current Derating Curve

Fig.2 Typical Reverse Characteristics

Fig.3 Typical Forward Characteristic

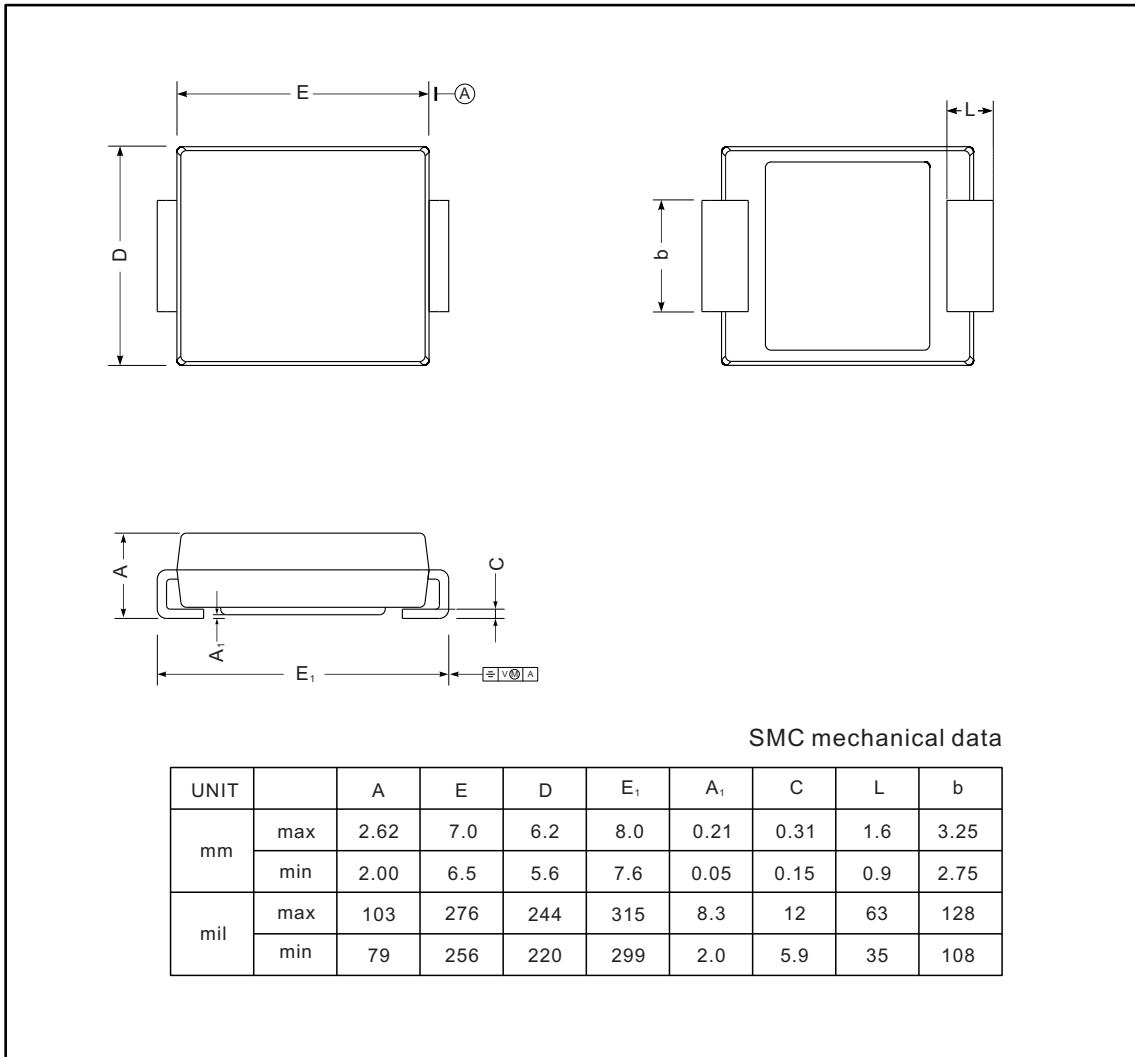
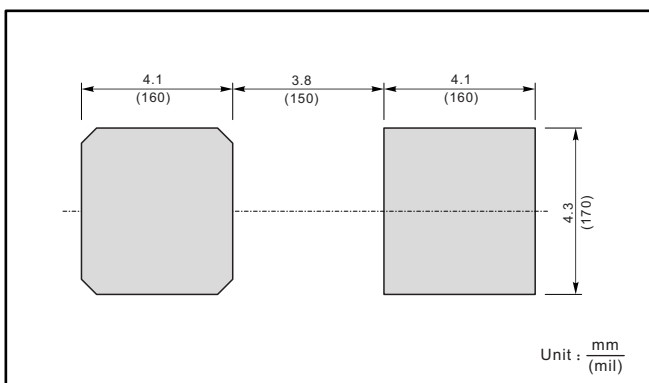
Fig.4 Typical Junction Capacitance

Fig.5 Maximum Non-Repetitive Peak Forward Surge Current

Fig.6- Typical Transient Thermal Impedance

PACKAGE OUTLINE

Plastic surface mounted package; 2 leads

SMC

The recommended mounting pad size

Marking

Type number	Marking code
SS82C	SS82
SS84C	SS84
SS86C	SS86
SS88C	SS88
SS810C	SS810
SS812C	SS812
SS815C	SS815
SS820C	SS820